

User manual

Smart Lift®

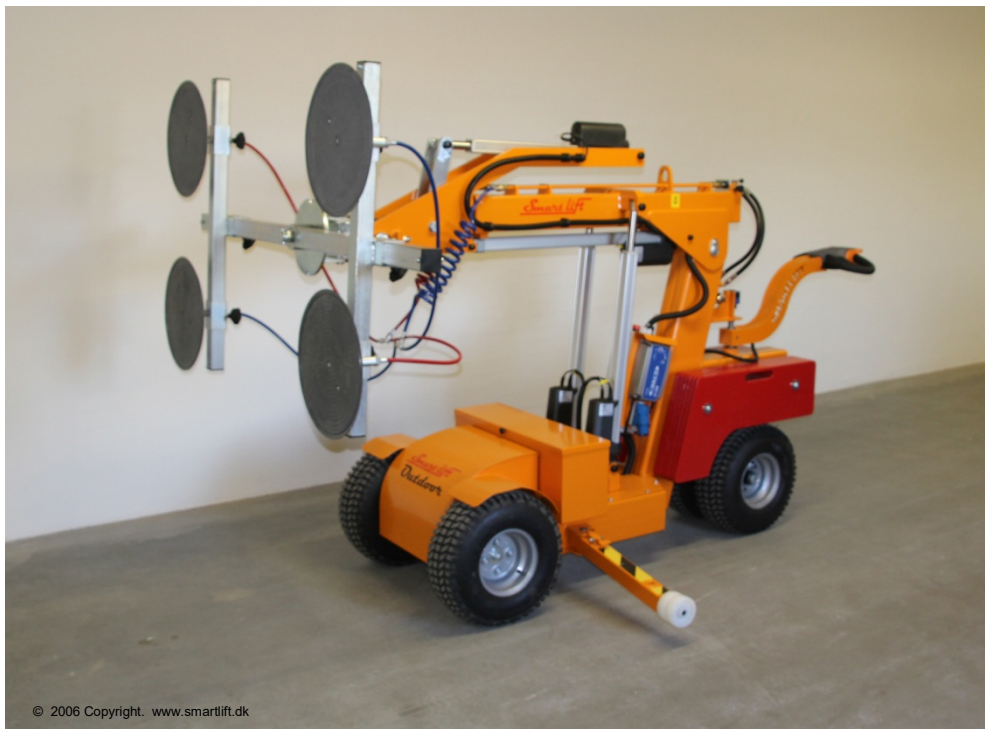

Model/type: **SL 608 OUTDOOR High Lifter – 1.63 hp**

Table of Contents:

Table of Contents	2
Introduction	3
EU Declaration of Conformity	4
General Description	5
Transport/Handling/Putting into Operation/Storage	6
Technical Data, Safety Rules	7
Overview/ - General Description	8
Operation for Vacuum function	10
Control for arm and yoke	10
Important Operation (vacuum & electric functions)	11
Electric Functions	11
Charger & Battery Case	12
View of Vacuum system (top and bottom of machine)	13
Control Box	14
Switches and Alarms	14
Control Panel for arm and yoke	15
Manual extension	16
Extra movement in tip function	17
Load Diagram	18
Stop-Down Troubleshooting of SmartLIFT	21
Information and manual charger	31
Wiring Diagrams	32

Introduction

Congratulations on your new SmartLift 608 OUTDOOR High Lifter.

Smartlift has been designed and constructed so as to safeguard product users against accidents as far as at all possible.

Unfortunately, certain functions in a machine cannot be safeguarded. This is why safety rules have been prepared by way of warnings in this instruction.

Read these safety rules on the following pages before putting your Smartlift into operation, and imagine how you may, in your daily use of the machine, ensure that warnings and safety rules will be adhered to.

Yours Sincerely,

Nicolai T. Jørgensen
Smartlift A/S
N.A. Christensensvej 39
DK-7900 Nykøbing Mors
Telephone +45 9772 2911
E-mail : smart@smartlift.dk

www.smartlift.dk

EU Declaration of Conformity



Manufacturer
SmartLift A/S
N.A. Christensensvej 39
DK - 7900 Nykøbing Mors

Hereby declares that:

The machine/system: Lift
Model/type: SL 608 OUTDOOR High Lifter – 1.63 hp
Serial No.:
Year/Month: 2016

has been made in conformity with Council directive

- Machine directive 2006/42EC
- Low voltage directive 2006/95/EC + 2014/35/EU
- EMC directive 2014/30/EU

The following standards have been applied:

DS/EN ISO 12100-1:2005	(Machine Safety – Basic concepts)
DS/EN ISO 12100-2:2005	(Machine Safety – Basic concepts)
DS/EN 1050:1997	(Principles of Risk Assessment)
DS/EN 294	(Machine Safety – Danger Areas and Safe Distances)
DS/EN 1757-1:2001	(Lift with walking operator)
DS/EN 13155/A1:2005	(Cranes – Safety – not fastened lift devices for loading) paragraph 7 “Information for use”
DS/EN 60204-32:2001	(Electric equipment on machines part 32 : Provisions for lifting machines)

Date:

Signature:

Nicolai T. Jørgensen, Director

General Description

Pos.no.	Product	Number
Vacuum		
1	Pump 007	2
2	Suction Cup diam. 15.75 "	4
3	Check Valve ½", vacuum	1
4	Replacement rubber t/suction cup	1
5	Slide Valve w/lock, vacuum	1
6	Vacuummeter diam.63 ¼", stainless	1
10	Hose Set	1
11	Hose Coupling	2
12	Spiral Hoses	2
13	Vacuum Guard	1
15	Alarm Light, Vacuum	1
16	Acoustic alarm, Vacuum	1
17	Line Filter	1
19	Stainless Spring	4
20	Clamp MRX.80 P-M10-25	6
21	Actuator – Tilting function LA 36	1
22	Actuator – Side Change	1
23	Actuator – Telescopic Arm	1
24	Actuator – Lift Arm LA 36	2
Power Supply		
25	Battery 105a	2
26	Charger Blue Power Charger IP65	1
Wheels		
27	Wheel, driving wheel	2
27a	Wheel, dual wheels	
30	Supporting Wheel	2
24 V		
31	Safety Switch/Telemecanique	1
32	Control Panel	1
33	Emergency Stop	1
34	Control, Lift Arm	1
35	Control, Telescopic Arrm/Tilt	1
36	Control, Side Change	1
37	CE Connector	1
38	Ermox Main Switch 24 V	1
39	Fuse 60 Amperes Control	
Various		
40	Lock Split	1
41	Lift Eye	1
44	Handle	3
45	Weight Blocks 1.18"	12
46	Supporting Leg	2

Drive		
47	Motor 1200 W/24 V	1
47a	On/OFF Switch for Drive Motor	1
47b	Fuse 100 Amperes for drive engine	1
47c	Fuse 10 Amperes Motor controller	1
48	Regulating Lever	1
49	Curtis Motor Control	1
50	Safety Clamp	1
51	Safety Switch	1
52	Forward and Back Switch	1
53	Protective Cap for forward and back switch	1

Transport/Handling

SmartLift is for indoor and outdoor use. Do not expose the machine to heavy rain and snow.

Prior to transport, switch off all electronics on main switch (pos. 38).

SmartLift to be fastened securely in truck/trailer for transport and protected against direct rain and snow.

Lifting by crane or similar: Always lift SmartLift in lift eye intended for this purpose (pos. 41).

NEVER lift under SmartLift with forks (fork-lift truck and similar)

Putting into Operation

Prior to putting into operation, insert vacuum hoses, and charge battery fully. The operator must have read the user manual and make sure that all security issues are respected. The user manual must always be at hand by the machine.

Storage

Always switch off your SmartLift on the main switch (pos. 38), before storage.

SmartLift should be kept in a dry place.

Batteries should always be fully charged.

Technical Data

Total Height	60,24 "
Total Width	33 "
Total Length	90 "
Net Weight	1296 lb
Weight Blocks	62.8 lb x 12 units = 754 lb
Total Weight incl. 12 weight blocks	2050 lb
24 V DC	
Charger 110V 60Hz 14A – CE plug	

Safety Rules (Pages 9, 11, 14)

Daily Use

Your Smart LIFT may only be used by persons who have been given qualified training in the operation of this machine and its safety functions.

Before use, user should check that there are no loose objects on the machine since this would entail breakdown and danger risks.



WARNING! Vacuum!

Working at the machine will entail danger if the various safety devices, pressure gauge (pos. 6), and acoustic alarm (pos. 16) are faulty.

Work may not be lifted until the light and acoustic alarms (pos.15, pos. 16) have stopped.

Do NOT lift moist or greasy work by the suction cups.



WARNING! Risk of overturning!

This machine MUST stand on a horizontal, firm, and stable base, with its supporting legs (pos. 46) unfolded.



WARNING!

Prior to using the lift yoke, check that nut and lock split have been securely fastened.



WARNING! Explosion Danger!

This machine may NOT be used in ATEX area. (Explosion danger environment).



DANGER!

Staying under the lifted work is strictly prohibited.

PROHIBITED!

May NOT be used for person lifting.



User manual

The operator must have read the user manual and make sure that all security issues are respected. The user manual must always be at hand by the machine.

Overview/ - General Description (pages 8, 9, 11, 14)

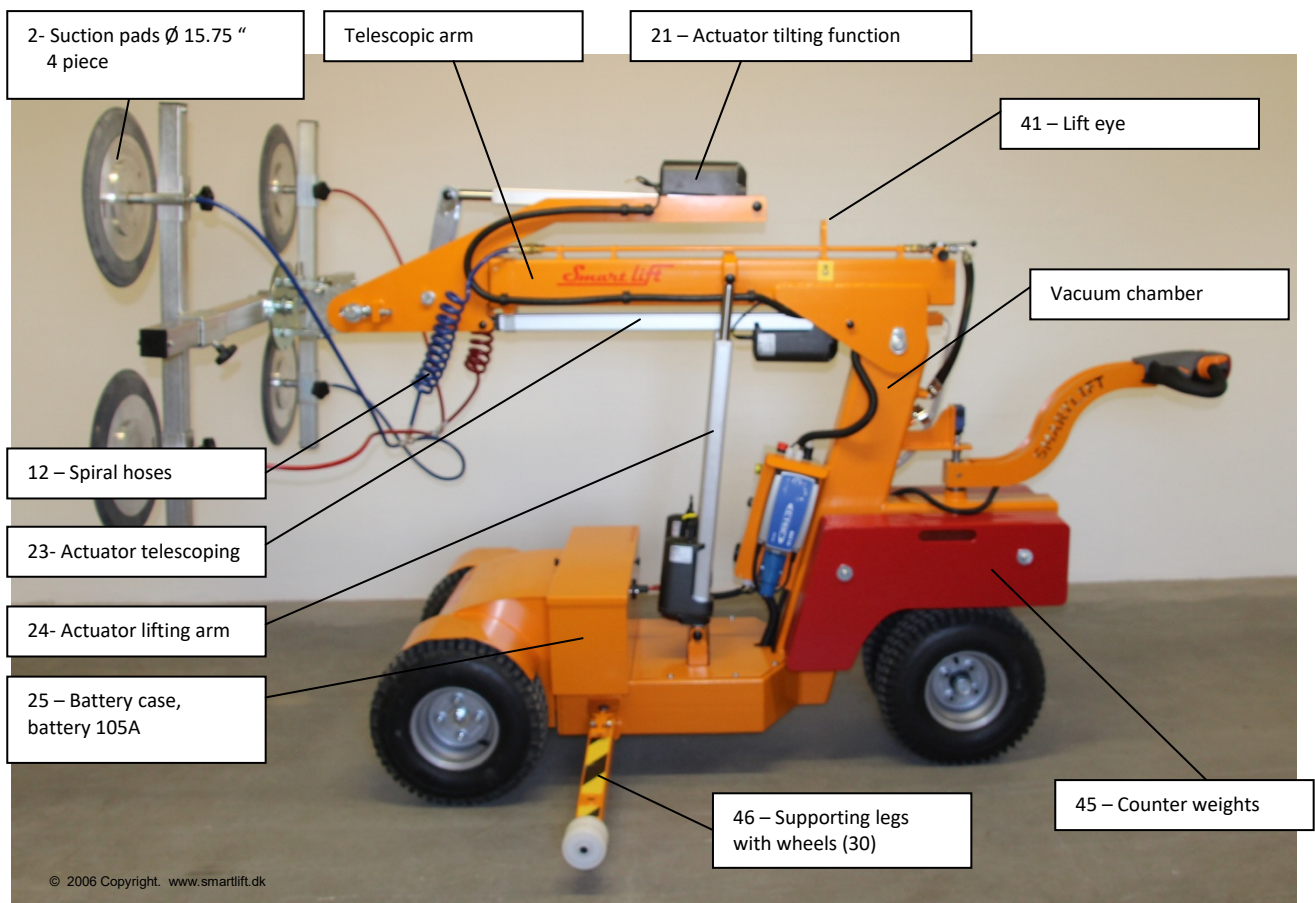

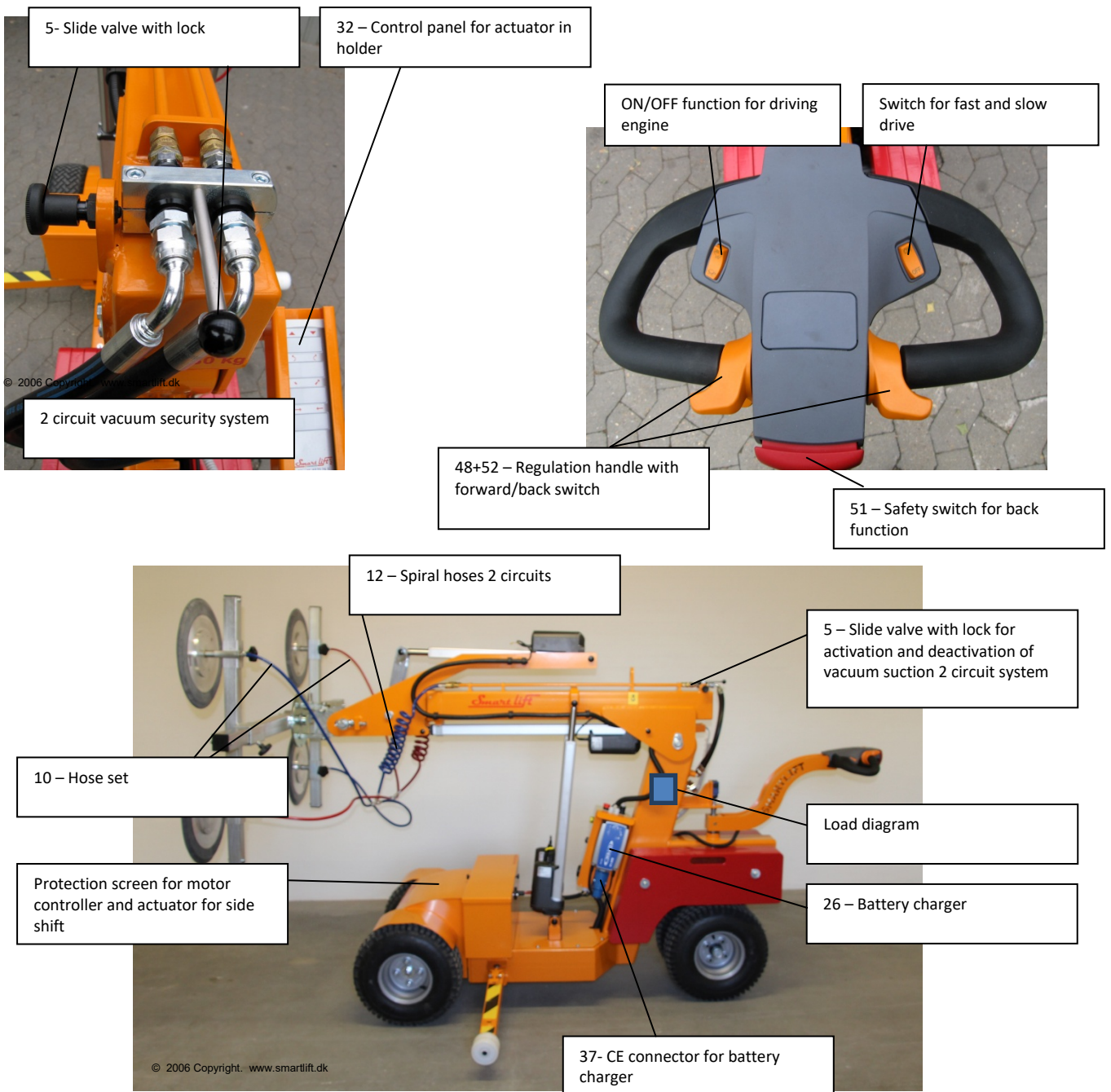

IMPORTANT!!!!!!

THE SUPPORTING LEGS MUSTS ALWAYS BE UNFOLDED WHEN DRIVING OFF ROAD TO PREVENT THE MACHINE FROM TIPPING OVER.

Operation of VACUUM function: (page 13)

This function (pos. 5) will switch vacuum on and off. The vacuum pump is controlled by a vacustat. The pumps have been programmed to stop at -0,62.

The vacuum function is operated by the slide valve and safety pin on top of the telescopic arm (pos. 5). To activate vacuum, push the slide valve forward (pos. 5). To release vacuum, pull the safety pin to the left and pull the slide valve backwards.

For max. stability at transport of sucked work, the suction cups are to be centred and adapted to the transport work chosen. ***Operation of yoke with sucked work should always be conducted with caution***

Control Panel (pos. 32) for arm and yoke: (pages 8, 9, 15)

Users should make a point of reading the function description below, so as to become familiar with the functioning of the machine.

Smart LIFT is operated manually. This machine generally has four functions which may be operated individually.

UP/DOWN function:

This function will make the arm move either up or down. The movement is made via the actuators, (pos. 24).

TILTING function:

This function will make the work turn round. The movement is made by actuator, (pos. 21).

TELESCOPIC ARM function:

The movement is made via actuator, placed under the lift arm, (pos. 23).

SIDE DISPLACEMENT function:

This movement is performed via actuator, placed between the two front wheels. (pos. 22).

Electric functions: (pages 9, 11, 14)

STOP/EMERGENCY STOP function:

The emergency stop button (pos. 33) is placed on the actual control panel. This button will switch off actuators as well as drive motor.

MAIN SWITCH:

(Pos. 38) Placed on the battery case inside. Turn handle to switch off all electric functions.

DRIVE MOTOR, (pos. 47):

The drive motor is activated by an on/off switch (pos. 47a).
Then turn the regulating lever (pos. 48).

FORWARD AND BACK function, (pos. 52):

Toggle switch forward and back

SAFETY function, (pos. 51):

Activating the safety switch will stop the car, and the car will move forward.

Vacuum meter & safety switch

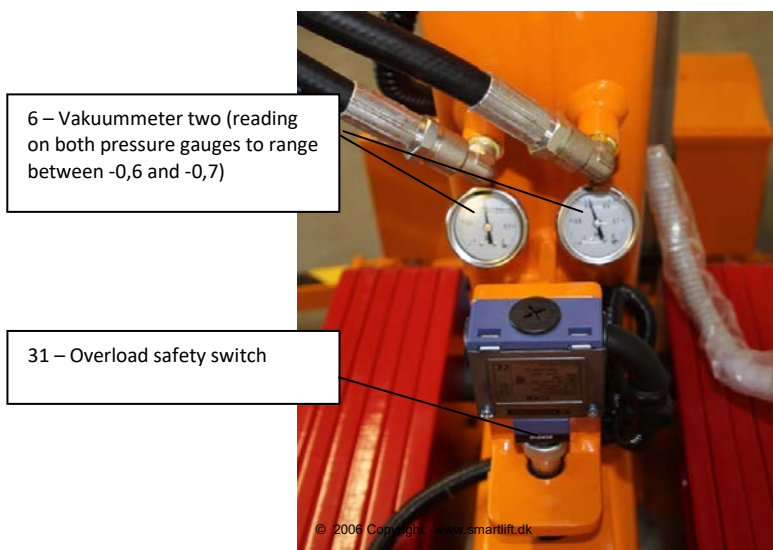

Charger

Victron Energy Blue Power Charger IP65 (pos. 26) – Battery Charger for lead acid batteries.

The blue Power charger is a three state charger (bulk-absorption float).

The absorption stage ends 2 hours after the charger current has reduced to 10% of the nominal current, with a maximum charge time of 18 hours.

Connection to the mains or reduction of the output voltage to 12V resp. 24V due to a DC load will trigger a new charge cycle.

Also please refer to page 29.

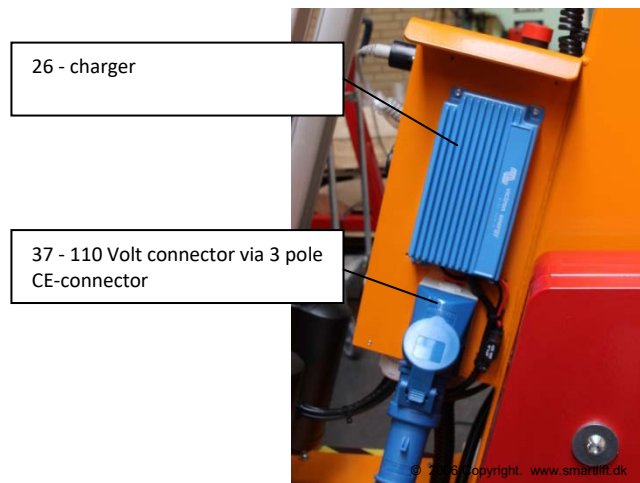

Battery case

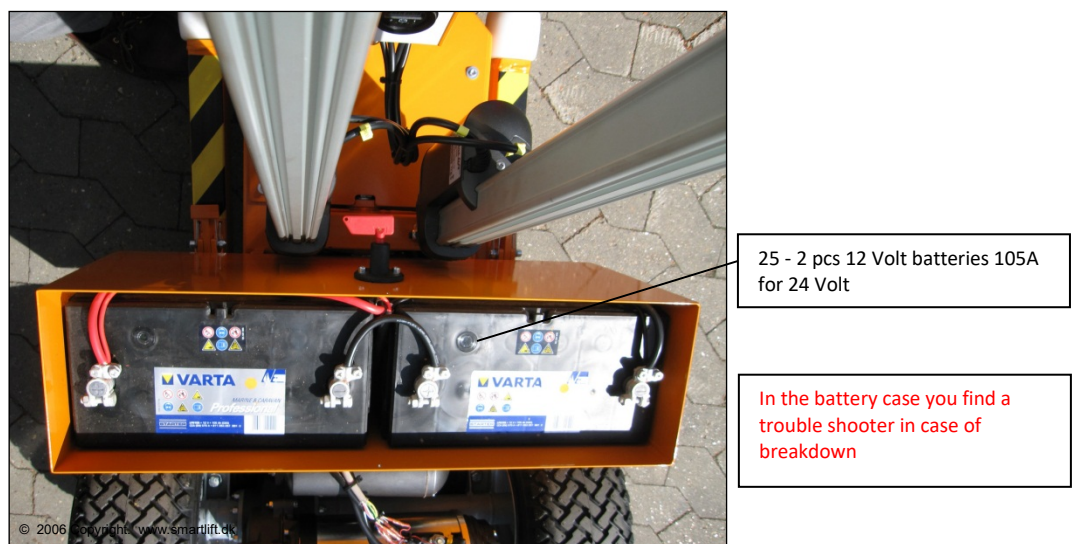

View of vacuum system

(top af machine)

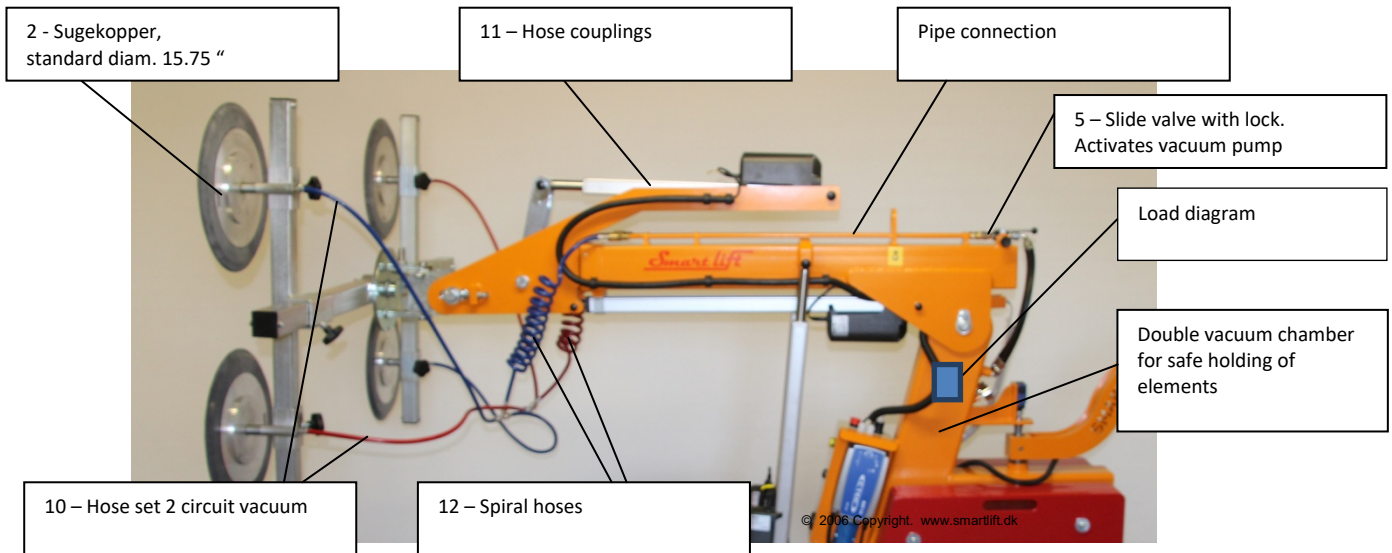

(bottom of machine)

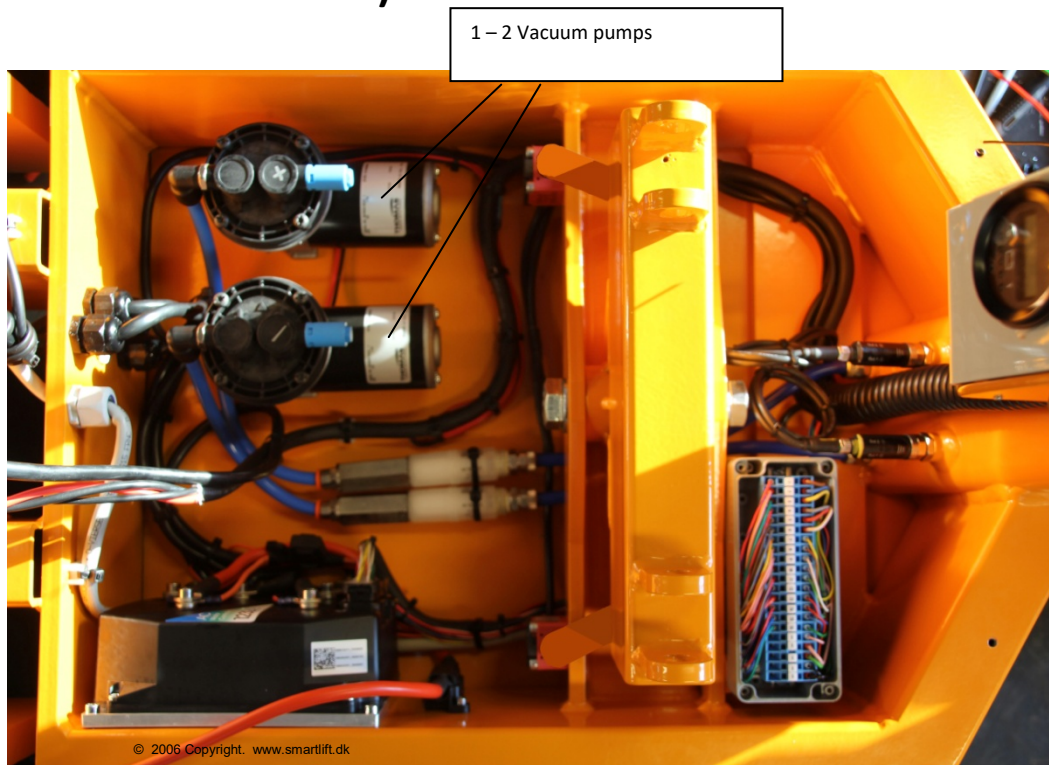

Control Box

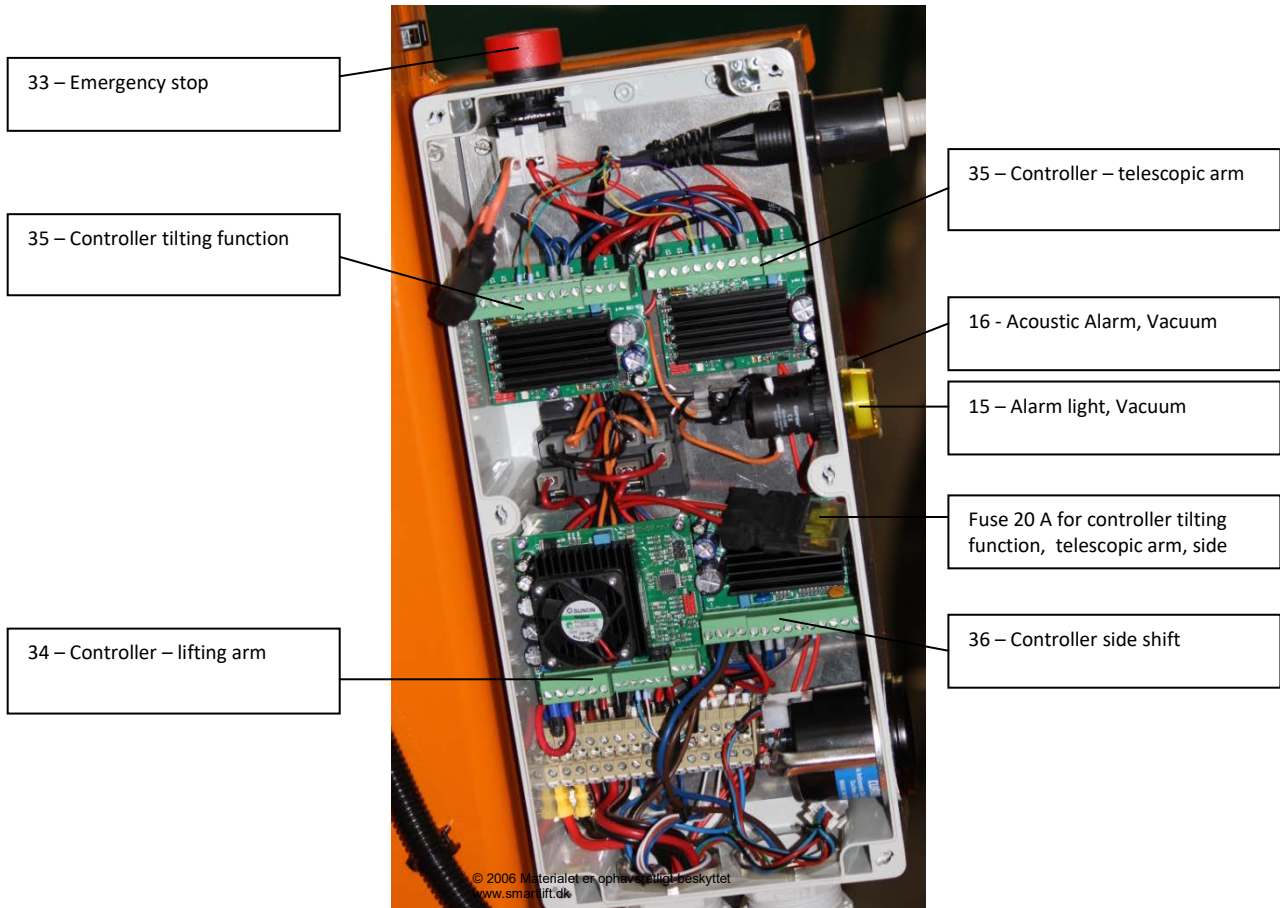

Switches and alarms

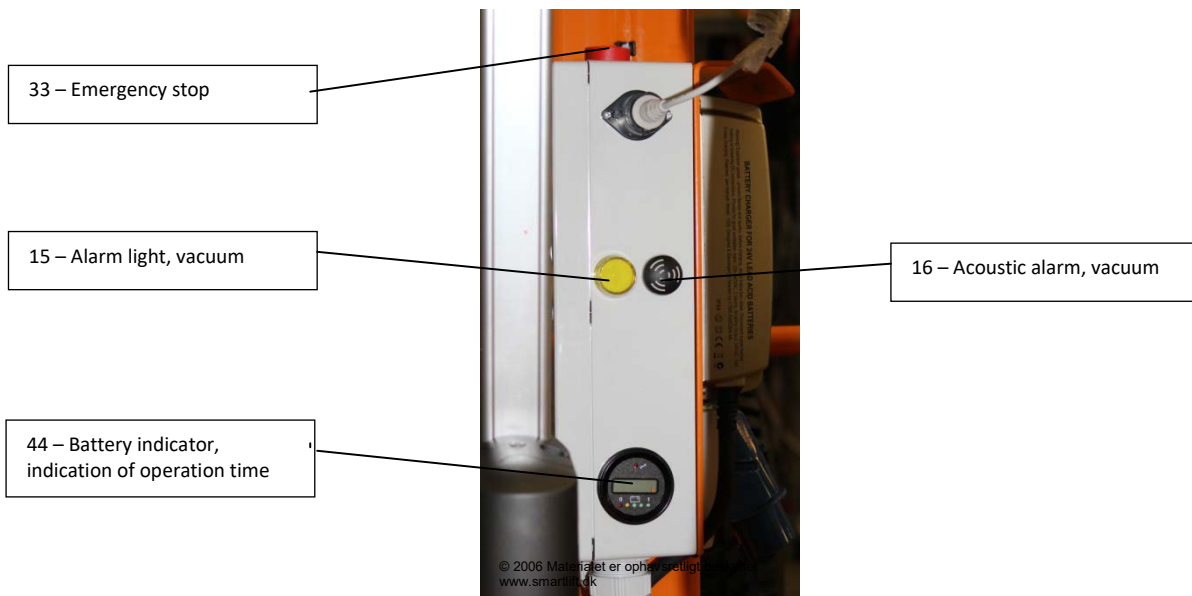

Control panel for arm and yoke (pos. 32)

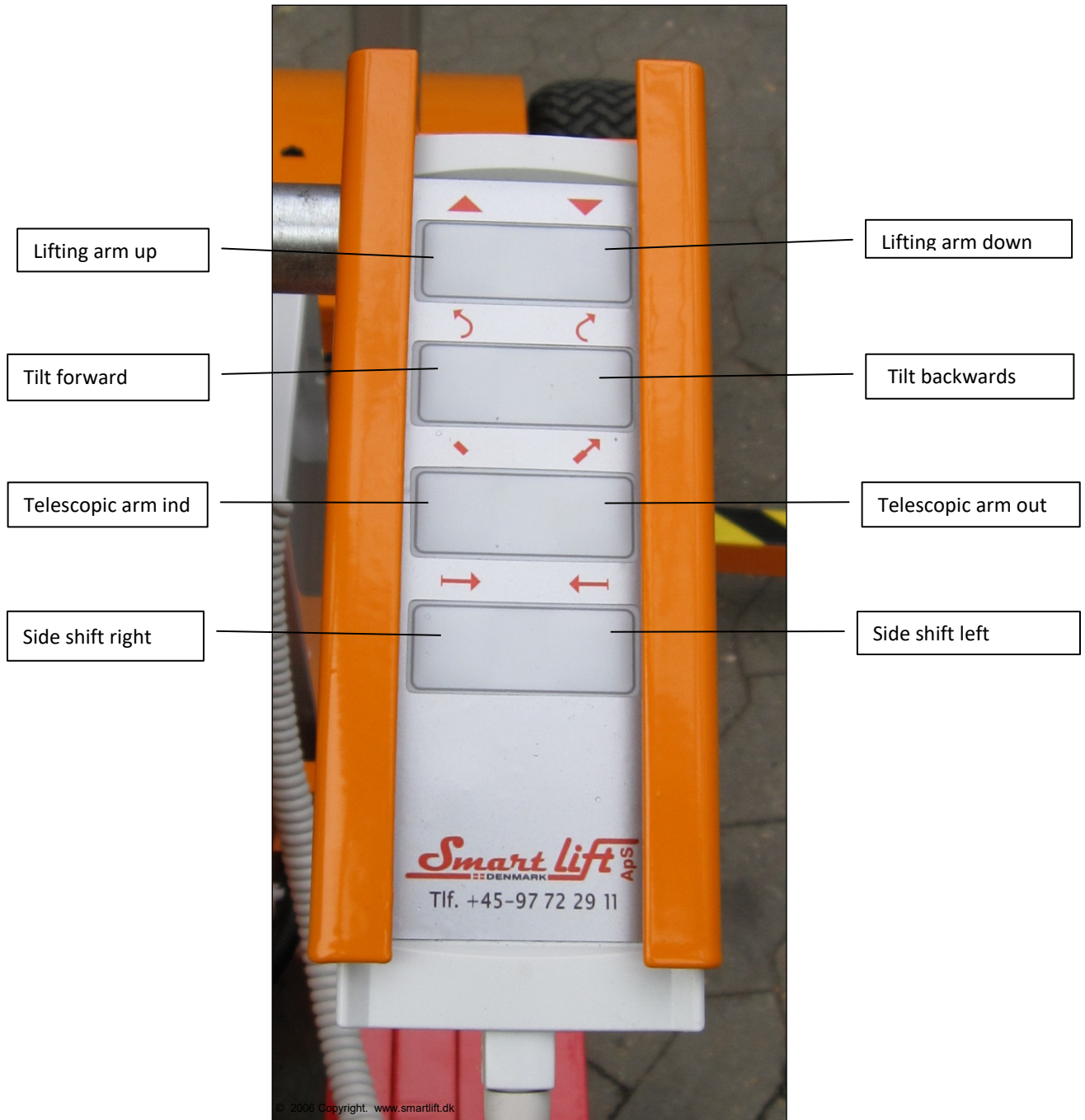

Manual extension

How to operate the manual extension



Before you start, make sure the main carrying arm is in the horizontal position

As operator, you are responsible for correct and safe operation. If you are in any doubt, do not use this function.



Pull out and lay split A to one side.



Pull out and lay bolt B to one side.



Pull or push the manual extension arm to the desired position.

There is a distance of 11.8 " between each hole.

NB! The fourth hole is the last one. Take care not to pull the extension arm too far or it will fall off.

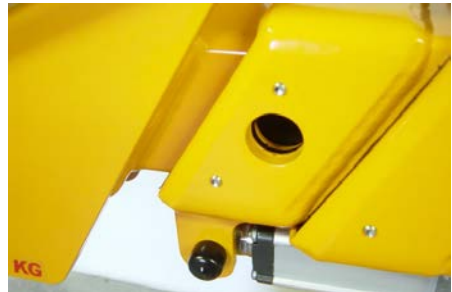

Tilt bolt B sideways until it slides into the hole.



Slide bolt B fully into place.



When the bolt is in place, slide split A through the bolt hole. To lock the split, turn the ring down over the bolt end.

Extra movement in tip function

The machine's tip head has two positions. The purpose of both is to increase the manoeuvrability of the machinery.



The red arrows indicate these two positions.



Before you start to change tip head position, ensure that the vacuum yoke is resting on firm ground/flooring.

As operator, you are responsible for correct and safe operation. If you are in any doubt, do not use this function.



When the yoke has settled, loosen the nut. Carefully remove the bolt and lay to one side. Use 2 x 0.9 " spanners.



Using the machine's remote control unit and the electrical functions, align the holes in the new position. When the holes are aligned, you can easily push the bolt into place.



Turn the nut and tighten a little. You should be able to turn the nut and bolt with your fingers but there should be no lateral slippage.

SL 608 OUTDOOR High Lifter

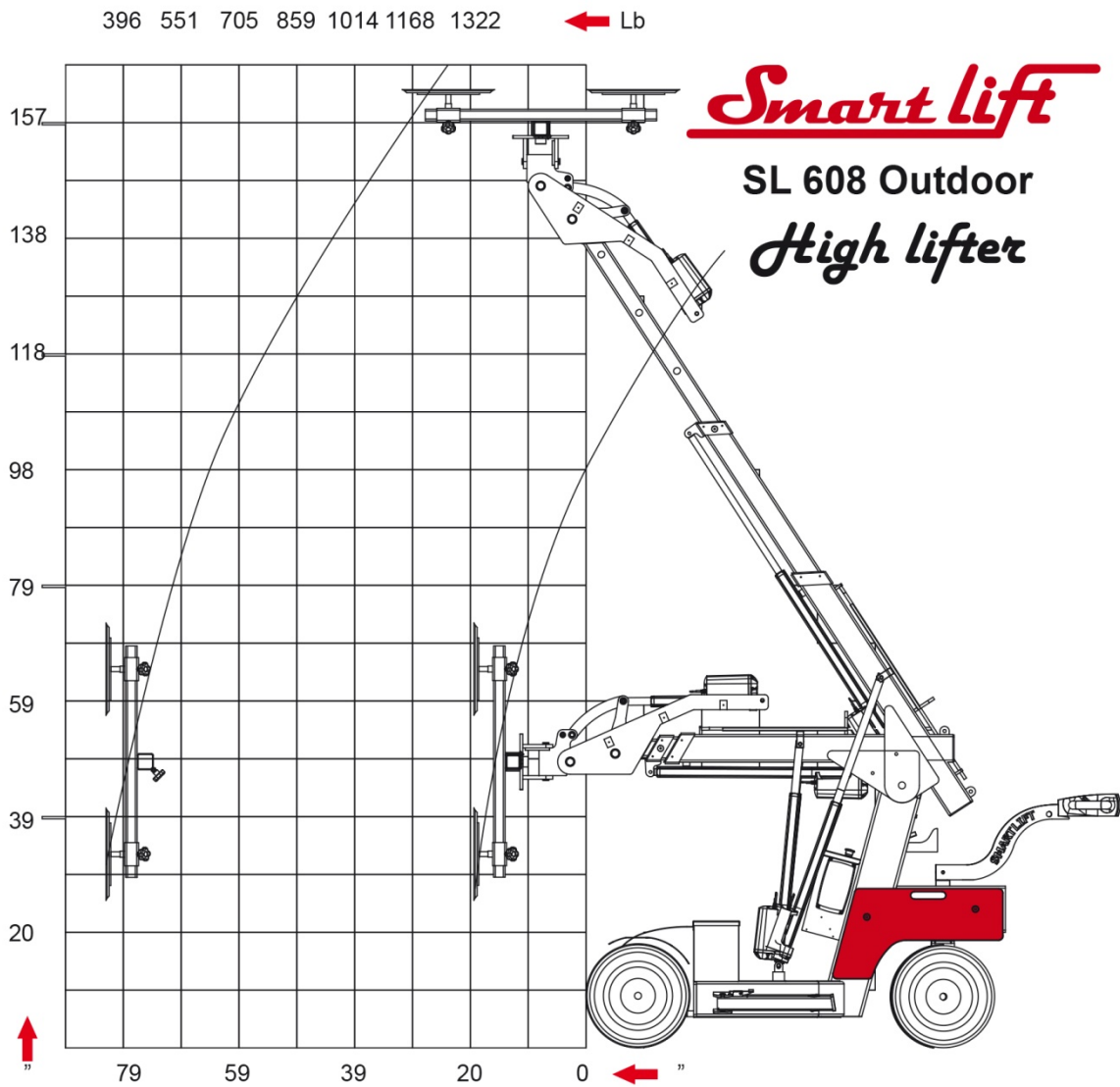

When operating SL 608 OUTDOOR High Lifter please be aware of:

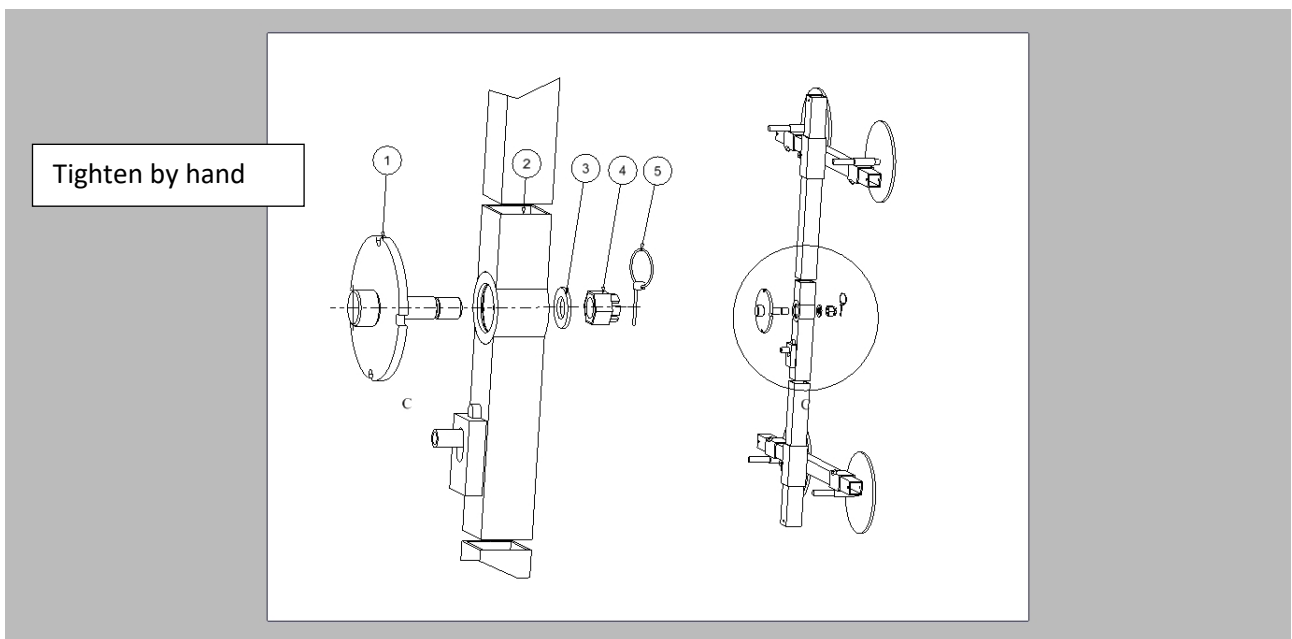
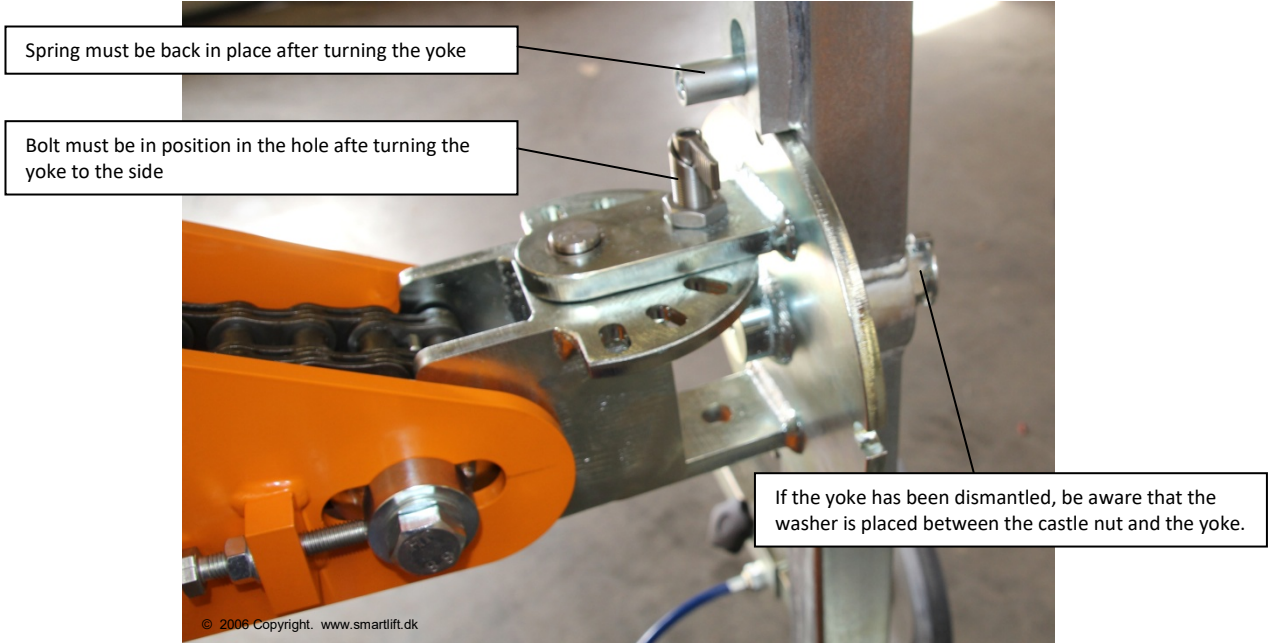

THE SUPPORTING LEGS MUSTS ALWAYS BE UNFOLDED WHEN DRIVING OFF ROAD



Supporting Leg Unfolded

© 2006 Copyright. www.smartlift.dk

Stop Down troubleshooting

For any fault on Smartlift, first look into the options below:

- Has anything visible been broken, or is anything unusual, about the machine? Is there any murmuring or noise?
- Have the batteries been charged, and the main switch switched on? (the On/Off button on the drive handle shall have been switched on (lighting) to read battery voltage on battery indicator)
- Has the emergency stop button switched the machine off? (placed on grey control box)
- Has the safety switch been switched off on account of overloading (placed under pressure switches)?
- Is the hose set intact, and has it been connected correctly?

Troubleshooting and remedying of faults will be divided into **3 overall categories:**

1. **Vakuum** (machine capacity for sucking work)
2. **Movements controlled via control panel** up and down function of lift arm, tilting of yoke, side displacement of machine.
3. **Drive controlled by regulating lever** – Forward and back function of machine.



1. Stop Down vacuum system



Slide Valve w/safety lock for activation and deactivation of vacuum suction.

Vacuum suction on both pressure gauges to be -0,62 bar (between -0,6 and -0,7)



If – vacuum pump will not run.

Always check that there is power on the machine, and that it has not been disconnected by switch or by fuse in the control box. Relay for pump may also be defective.

If – vacuum pump runs constantly.

Check that the slide valve is closed (should be closed to generate vacuum). Read pressure gauge (should be about -0,6 bar).

If – the pressure gauge indication is constantly about -0,7 bar or more.

In that case, there will be a fault on the vacuum guard.

If – the pressure gauge is constantly appr. -0,55 bar or less, and the pump is running.

In that case there would be a fault on the vacuum pump, or a leak on the hose connection between check valve and vacuum pump.

If – the pressure gauge indication drops after the main switch has been disconnected, and the slide valve closed.

In that case, there will be a fault – a leak between slide valve and check valve. Pressure gauge, slide valve or vacuum guard may be defective. If hoses are dismantled at couplings, and the pressure continues to drop, the fault will be with the slide valve.

If – the vacuum pump starts and runs constantly, possibly with dropping pressure, when the slide valve is opened, in connection with suction of work.

Check that all suction cups bear correctly on the work, i.e. that the particular suction cup is parallel with the work, and that no parts of the suction cups protrude from the work (IMPORTANT!!!).

If – the vacuum pump starts and stops at very brief intervals.

Dismantle spiral hoses at couplings and close the slide valve if this has not been done already. If the vacuum pump still starts and stops at very brief intervals, there may be a fault on the check valve.

If – the vacuum pump starts and runs, and stops at brief intervals, possibly with dropping pressure on one or both pressure gauges, when the slide valve is opened, after correct suction of work.

Close slide valve. Disconnect one vacuum circuit at hose coupling, and then open the slide valve for vacuum suction again. If the vacuum suction on the pressure gauge for disconnected circuit is now constantly -0,6 bar, there will be a fault on the hose set or at the suction cups in disconnected vacuum circuit. Test the same procedure in case of fault on the other vacuum circuit system. You may listen for leaks.

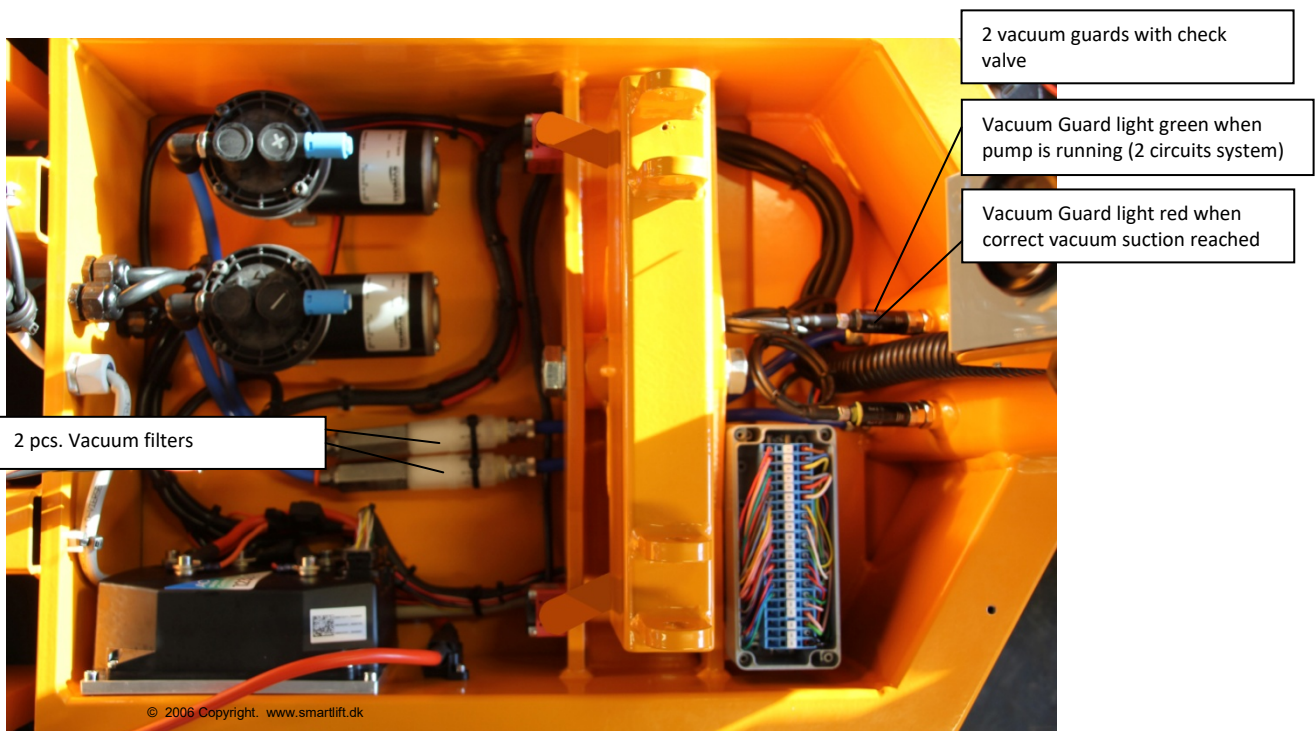

© 2006 Copyright. www.smartlift.dk

2. Stop-Down at "movements" controlled via control panel

If – no response to pushing control panel, all functions

Has emergency stop been released? Reconnect emergency stop by turning the release pressure. Check whether main switch is on (placed on battery case between lift actuators) – to be turned clockwise to switch on.

Check whether the control panel connector is correctly placed in the control box. Have batteries been charged? – on/off button on handle for drive should be on to read battery indicator?

Is 30-ampere fuse in control box OK?

Has the safety switch been activated? If activated, try to deactivate by pulling in the telescopic arm, or act as follows:

The safety switch has correctly the machine.

To re-establish function on the machine, you may, for instance, using a screwdriver push up the switch, and the safety switch will resume its function

The telescopic arm is run back in, and work too heavy for the machine is lowered back in place. Should the safety switch switch off again at this manoeuvre, you may, using your body weight, push the machine in place by applying pressure on the weight blocks.



If –no response when pushing control panel , individual functions,

Has the safety switch been activated? If activated, try one of the possibilities above. There may be a fault on actuators for movements, or when controlling these.

Actuators, and Control of these

For faults on movements of actuators, always first check visually and by review of the machine whether anything visible is wrong, or “wrong” from an acoustic point of view, from one of the actuators. Lines may be loose or torn, and bolts may be loose. Finally, the actual actuator telescopic arm may be bent. The machine has totally five actuators. 1 for tilting of yoke, 2 for lifting of arm, 1 for telescoping of arm, and 1 for side change.

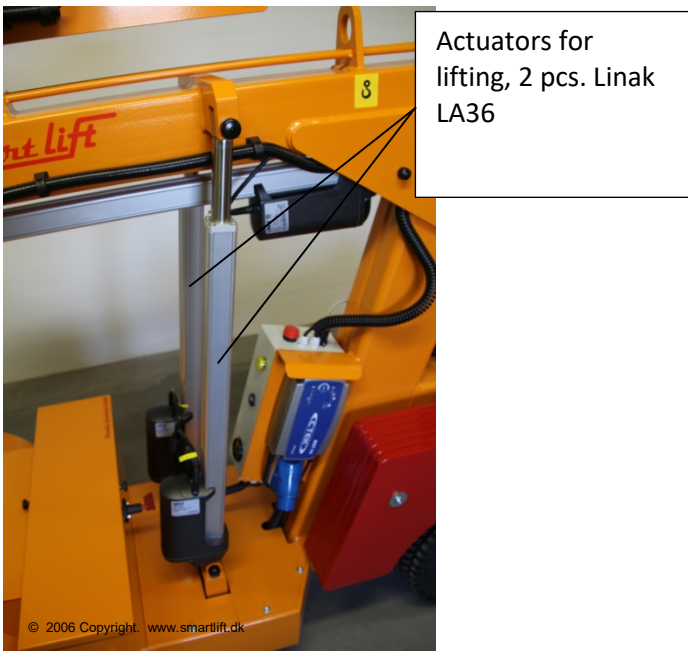
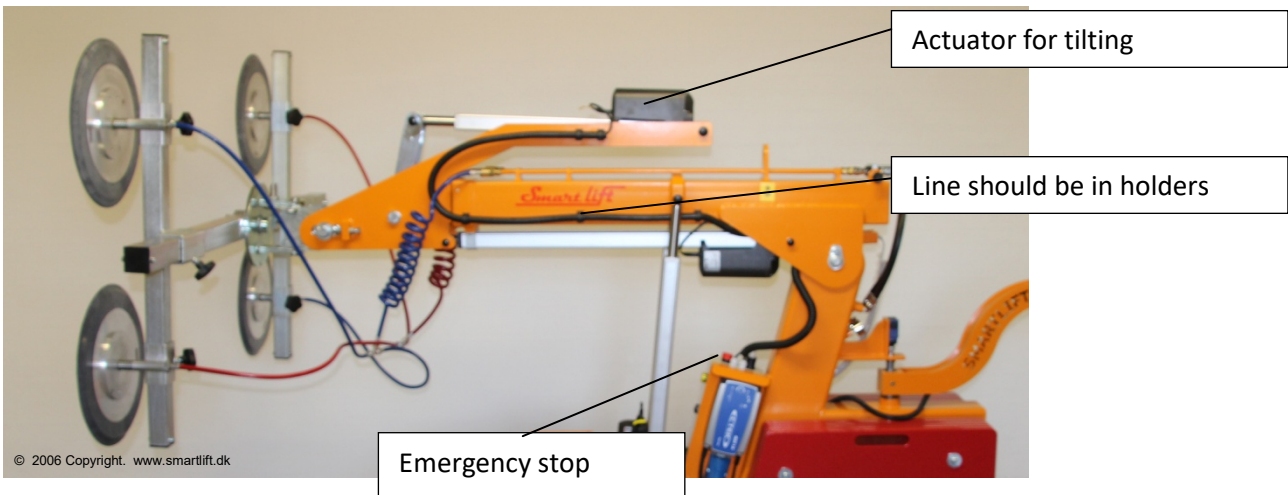

Fault on lift actuator

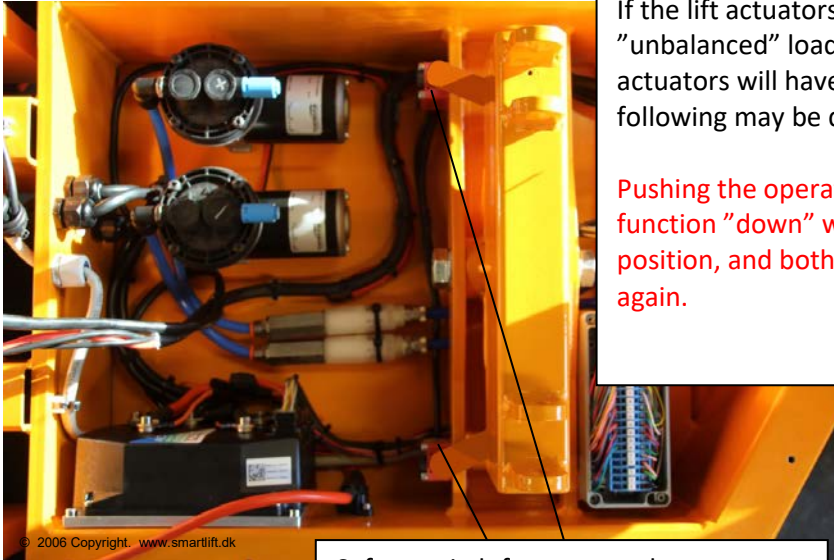

© 2006 Copyright www.smartlift.dk

If the lift actuators, or one of these, stop due to "unbalanced" load, one of the safety switches under the actuators will have switched off the power supply. The following may be done to re-establish normal function:

Pushing the operation panel button repeatedly to function "down" will run lift actuators to bottom position, and both actuators should run synchronously again.

Safety switch for non-synchronous running on actuator



© 2006 Copyright www.smartlift.dk

Actuator for tilt function

Actuator for telescopic arm

Here, too, all lines should be undamaged, and placed correctly at lead-ins etc.

Service sticker – According to legislation SL-OUTDOOR must be serviced once a year

Control box with controllers for all actuators

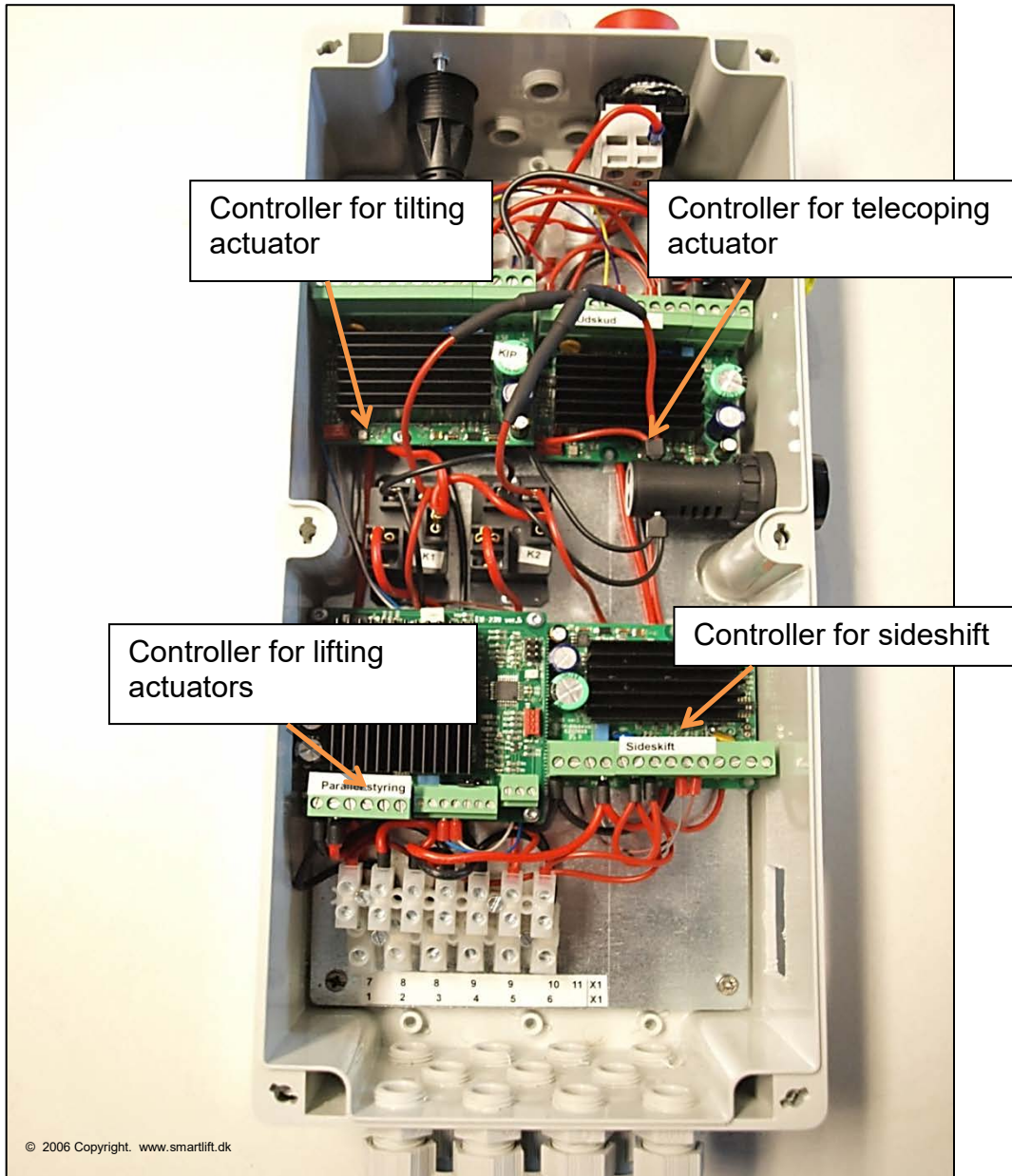

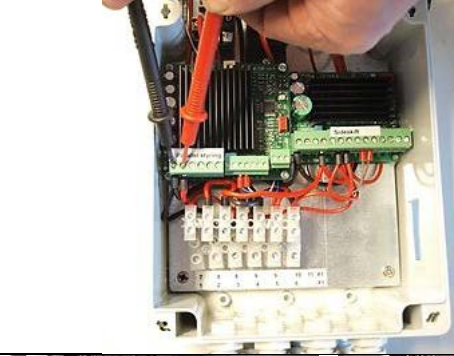
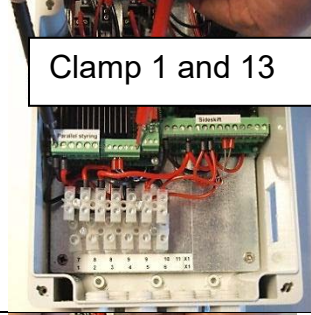
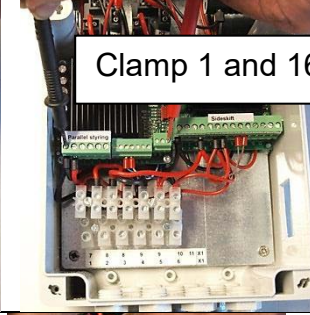
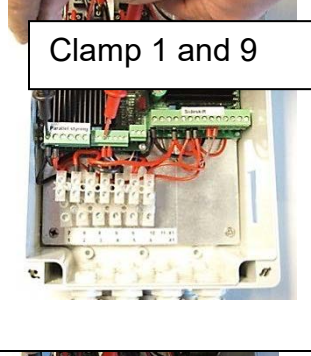
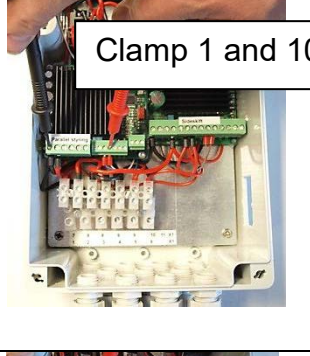
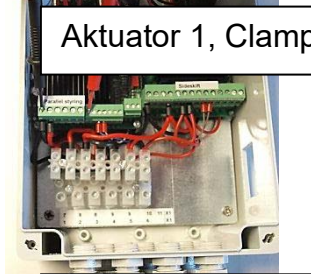
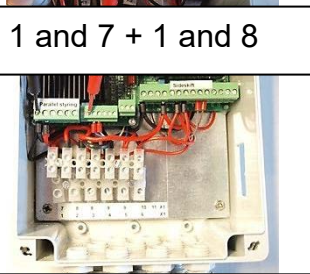
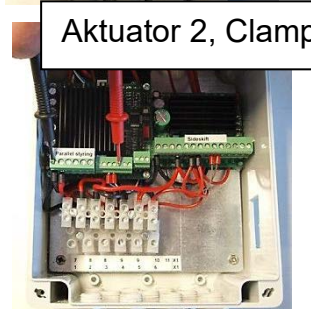
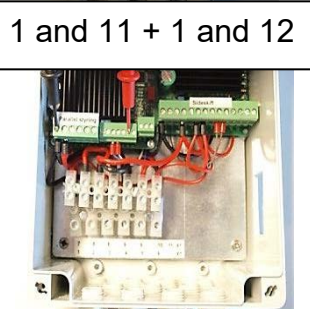

Synchronous controller (controller for lifting actuators)

<p>Controller for lifting actuators (2 pcs.) Voltage between clamps 1 and 2 must be approx. 24 Volt</p>	
<p>Safety switch below the lifting actuators can be switched off. Voltage between clamp 1 and 13 must be approx. 24 Volt</p>	<div style="display: flex; justify-content: space-around;"> <div style="text-align: center;">  <p>Clamp 1 and 13</p> </div> <div style="text-align: center;">  <p>Clamp 1 and 16</p> </div> </div>
<p>Press up and down on the remote control. Voltage between clamp 1 and 9 and 1 and 10 must be approx. 24 Volt</p>	<div style="display: flex; justify-content: space-around;"> <div style="text-align: center;">  <p>Clamp 1 and 9</p> </div> <div style="text-align: center;">  <p>Clamp 1 and 10</p> </div> </div>
<p>Possible faults on pulses from lifting actuator can be checked by activating the control panel in steps. At the same time measure the voltage between clamps 1 and 7 as between 1 and 8 for actuator 1. For actuator 2 between clamps 1 and 11 as between 1 and 12 The measuring device varies from 0-24 VOLT</p>	<div style="display: flex; justify-content: space-around;"> <div style="text-align: center;">  <p>Aktuator 1, Clamp 1 and 7 + 1 and 8</p> </div> <div style="text-align: center;">  </div> </div> <div style="display: flex; justify-content: space-around; margin-top: 10px;"> <div style="text-align: center;">  <p>Aktuator 2, Clamp 1 and 11 + 1 and 12</p> </div> <div style="text-align: center;">  </div> </div>

Controller for single actuator (sideshift, tilt of yoke, telescopic arm)

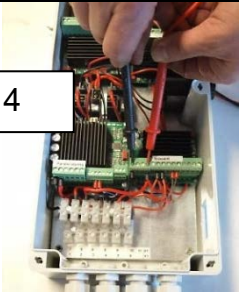
(The illustration is from sideshift controller. The procedure is the same for tilt and telescoping)

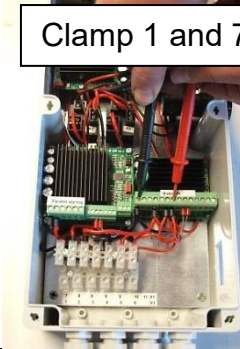
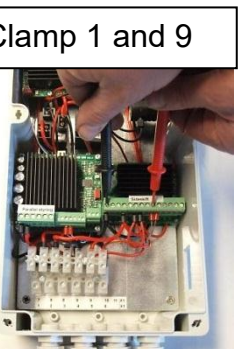
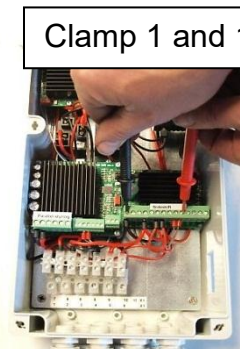
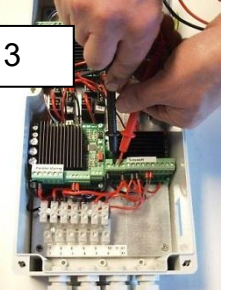
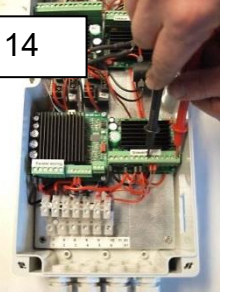
<p>No reaction on actuator for sideshift, tilt of yoke or telescopic arm.</p> <p>Voltage must be + 24 Volt (Clamp 1 and 4)</p>	 <p>Clamp 1 and 4</p>
<p>Security switch can be abrupted</p> <p>Voltage must be + 24 Volt between Clamps 1 and 6 as between 1 and 7</p>	 <p>Clamp 1 and 6</p>  <p>Clamp 1 and 7</p>
<p>Fault on remote control when moving single actuators</p> <p>Voltage must be + 24 Volt between clamps 1 and 9 as between 1 and 10</p>	 <p>Clamp 1 and 9</p>  <p>Clamp 1 and 10</p>
<p>Activate the control panel for movement of tilt, sideshift or telescopic arm.</p> <p>Voltage between clamps 2 and 3 must be 24 Volt or more</p>	 <p>Clamp 2 and 3</p>
<p>No reaction on movements and none of the above faults.</p> <p>Voltage between clamp 8 and 14 must be + 5 Volt</p> <p>If this is not the case, the print on the controller can be defective</p>	 <p>Clamp 8 and 14</p>

3. Stop-Down at Drive Section

If - no response at activation on regulating lever (no click sound)

Check whether the main switch is on – to be turned clockwise to switch on. Is the switch on the regulation handle for on/off in position ON? – Have the batteries been charged (check indicator)?

Is the 100 Ampere fuse for the driving motor intact? Is the 10 Ampere fuse for the motor controller intact?

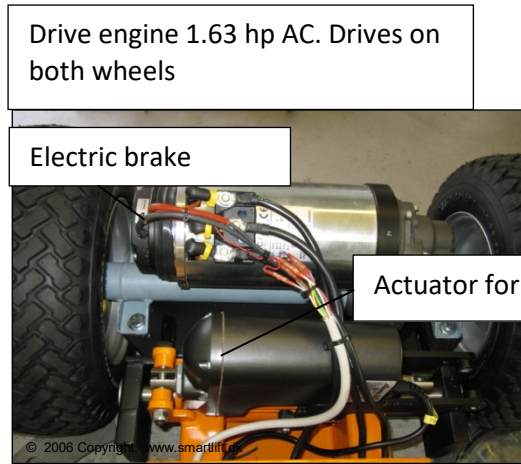

Tyre pressure max for all four wheels:
43 PSI/2,95 Bar/295 Kpa.

Battery charger

Victron Energy - Blue Power Charger IP65



For complete manual refer to:

<https://www.victronenergy.com/upload/documents/Datasheet-Blue-Power-Battery-Charger-IP65-90-135VAC-EN.pdf>

INDICATIONS:

LED indication

Yellow LED on:

Yellow LED on and green LED on:

Green LED on:

Description

battery being charged.

absorption charge.

battery fully charged, float charge.

WIRING DIAGRAMS

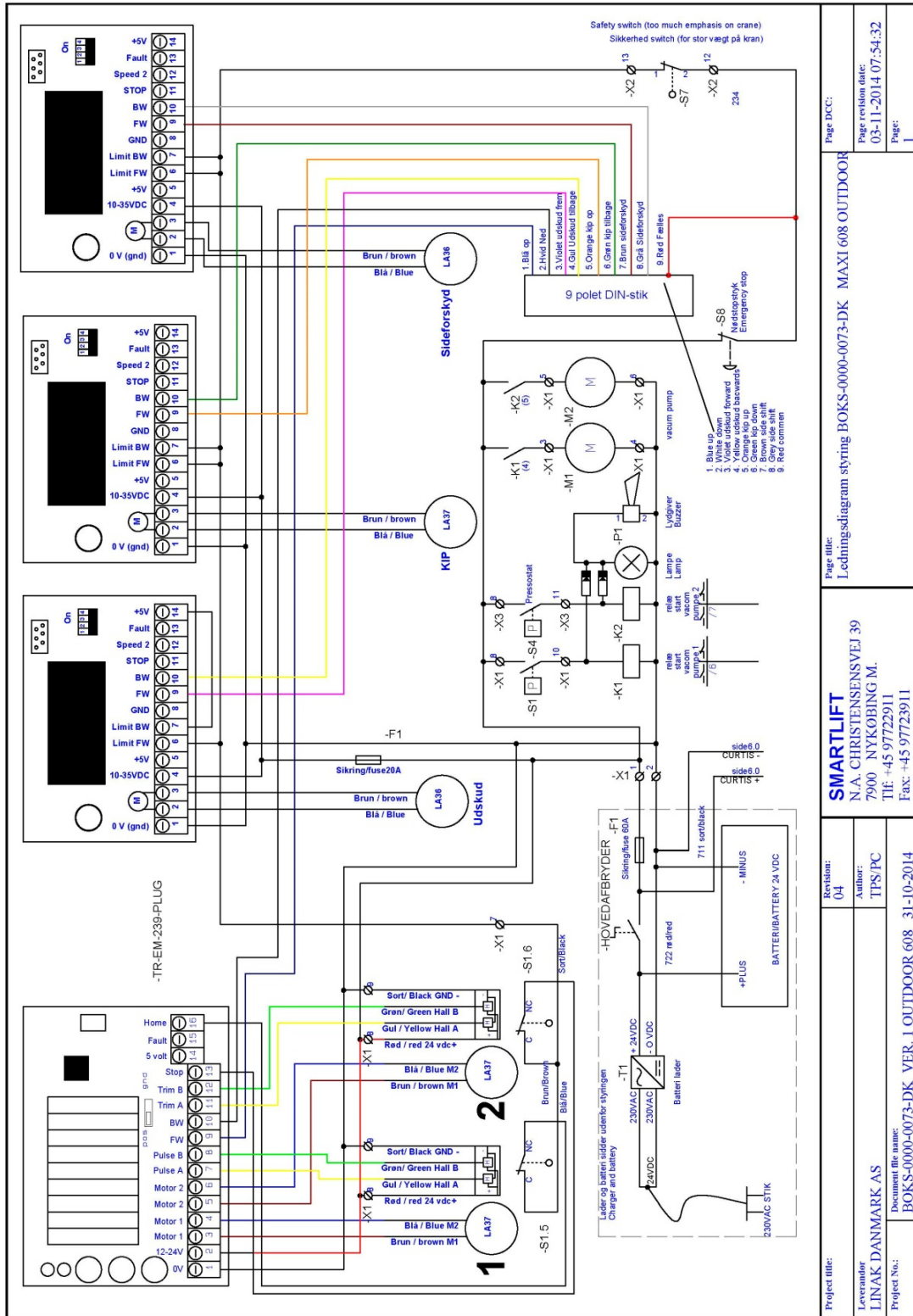

Page DCC:
Page revision date:
03-11-2014, 07:54:32
Page:
1

Page title:
Ledningsdiagram styring BOKS-0000-0073-DK MAXI 608 OUTDOOR

SMARTLIFT
N.A. CHRISTENSENVEJ 39
7900 NYKØBING M.
Tlf: +45 9722911
Fax: +45 9723911

Revision:
04
Author:
TPS/PC

Project title:
Leverandør
LINAK DANMARK AS
Document file name:
BOKS-0000-0073-DK VER. 1 OUTDOOR 608
31-10-2014

Wiring for SL 608 Outdoor High Lifter

Engine	Brown	1	Pin 13 Red/Blue	Curtis controller
	Blue	2	Pin 5 Pink	
	Yellow	3	Pin 8 Green	
	Grey	4	Pin 32 Red/Green	
	Red	5	Pin 26 Brown	
	White	6	Pin 31 Grey/Blue	
Steering	Yellow	7	Pin 24 Yellow/Red	
	Brown	8	Pin 11 Pink	
	White	9	Pin 33 Pink/Black	
	Grey	10	Pin 16 Grey/Black	
	Green	11	Pin 1 Red	
	Blue	12	Pin 22 Violet/Red	
	Red	13	Red	
Battery Indicator	Red	14	Pin 25 Red	
	Blue	15	Pin 28 Blue	Curtis controller
	Green	16	Pin 29 Green	
Engine	Green	÷	Negative	
	Pink	÷		
Steering	Pink	÷		
Battery Indicator	Black	÷		
Curtis controller	Black Pin 7	÷		

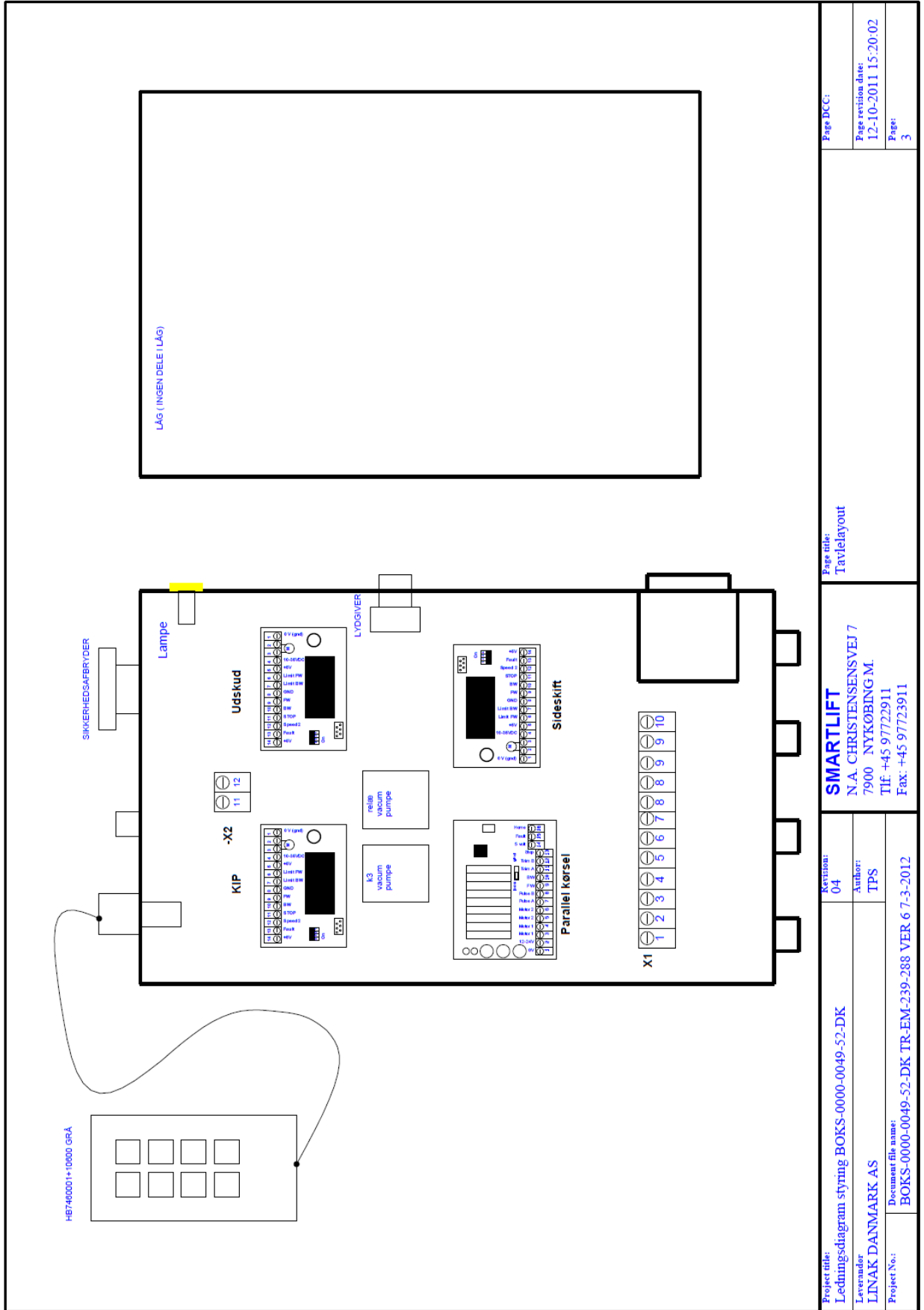

Project title: Ledningsdiagram styring BOKS-0000-0049-52-DK Leverandør: LINAK DANMARK AS Project No.: BOKS-0000-0049-52-DK TR-EM-239-288 VER 6 7-3-2012	Revision: 04 Author: TPS	SMARTLIFT N.A. CHRISTENSENVEJ 7 7900 NYKØBING M. Tlf. +45 97722911 Fax. +45 97723911	Page title: Tavlelayout	Page DCC: Page revision date: 12-10-2011 15:20:02 Page: 3
--	-----------------------------------	--	----------------------------	---